

TEMPLATE KEY

-  = BLEED AREA
-  = FINISHED SIZE
-  = SAFE AREA
-  = STITCH LINE

BLEED AREA

N/A

Area of art that is used for finishing product. Background color/image should extend into this area.

FINISHED SIZE

23"W x 34.25"H - PANEL
22.75"W x 10.75"H - HEADER

Area of art that is visible after finishing product. Background color/image should extend into the bleed area.

SAFE AREA

21"W x 32.25"H - PANEL
20.75"W x 8.75"H - HEADER

Recommended area to place artwork. Artwork within this area will be safe from variance in cut of finished edge /stitch line.

Using PMS colors in your art is recommended but an exact match cannot be guaranteed.

Digital products are printed **CMYK (4 color) process** from your file.

**FOR REFERENCE ONLY
PLEASE USE FULL SIZE
TEMPLATES ON PAGE 2
TO SET UP ARTWORK**

- All images must be embedded
- All fonts must be outlined.

ACCEPTABLE FILE FORMATS:



Vector lines Vector image

- Adobe Illustrator (.ai, .pdf, .eps)
- All Fonts Outlined
- Images Embedded



Raster image

- Adobe Photoshop (.psd, .tif, .jpg)
- 200 DPI at 100% Scale

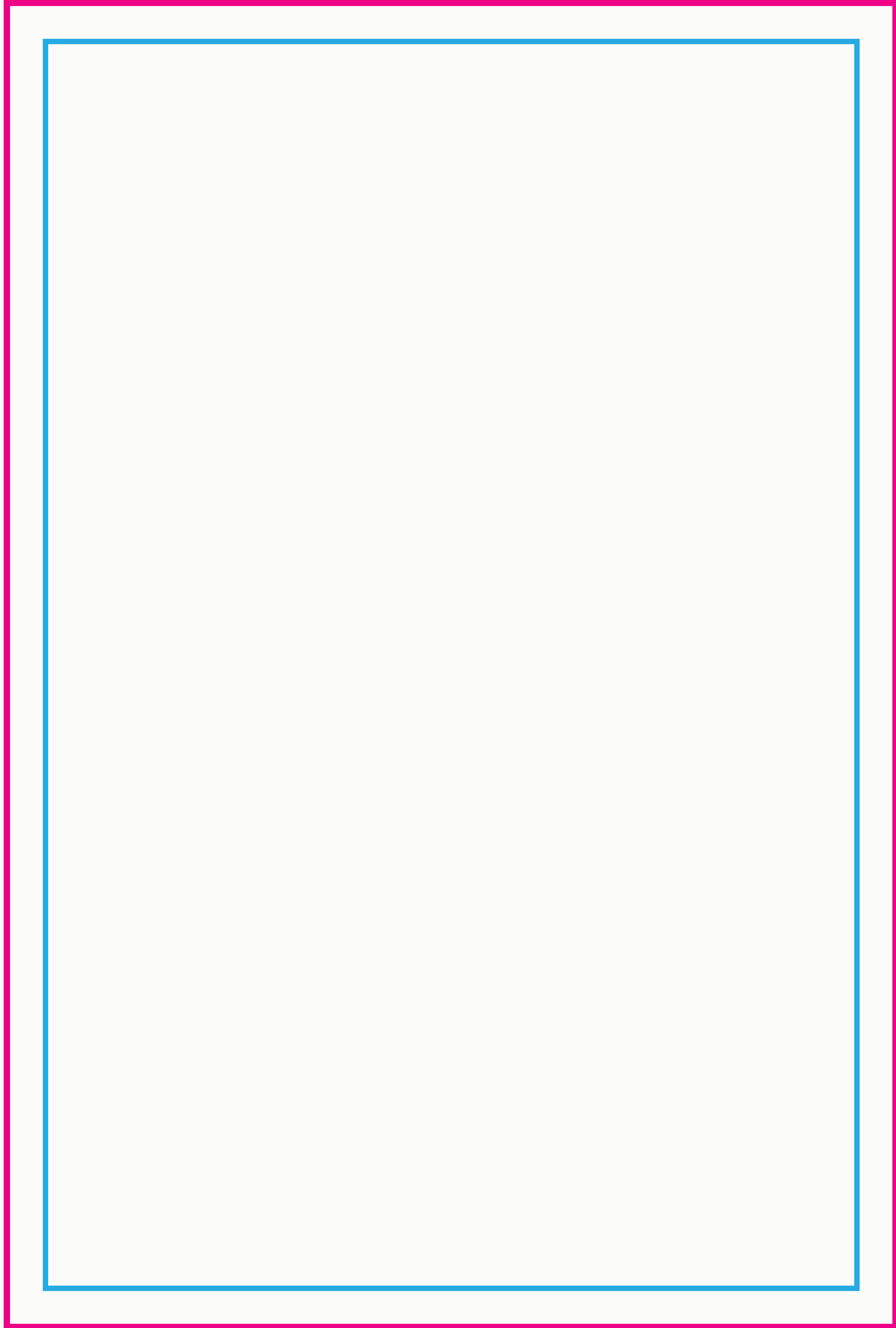
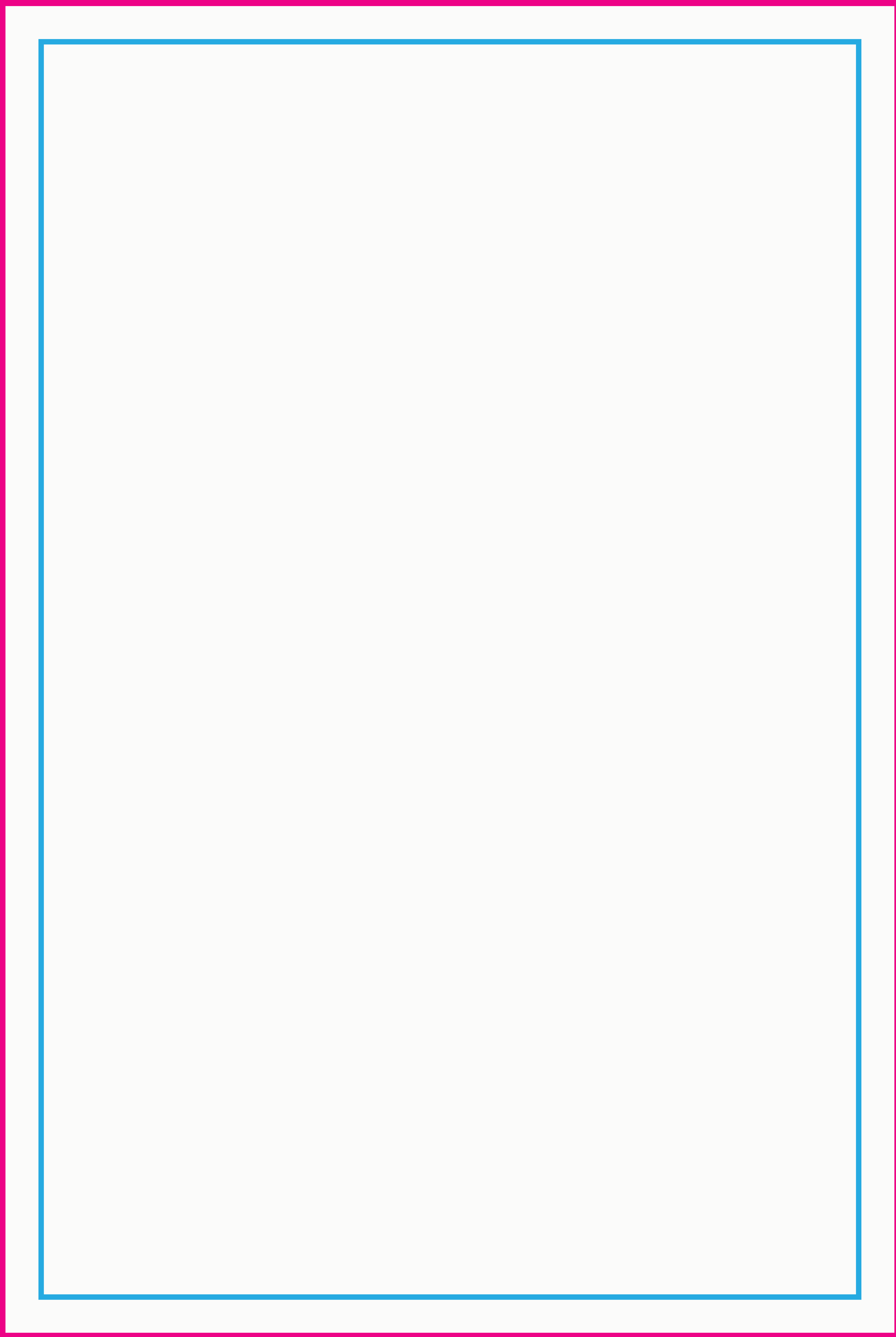
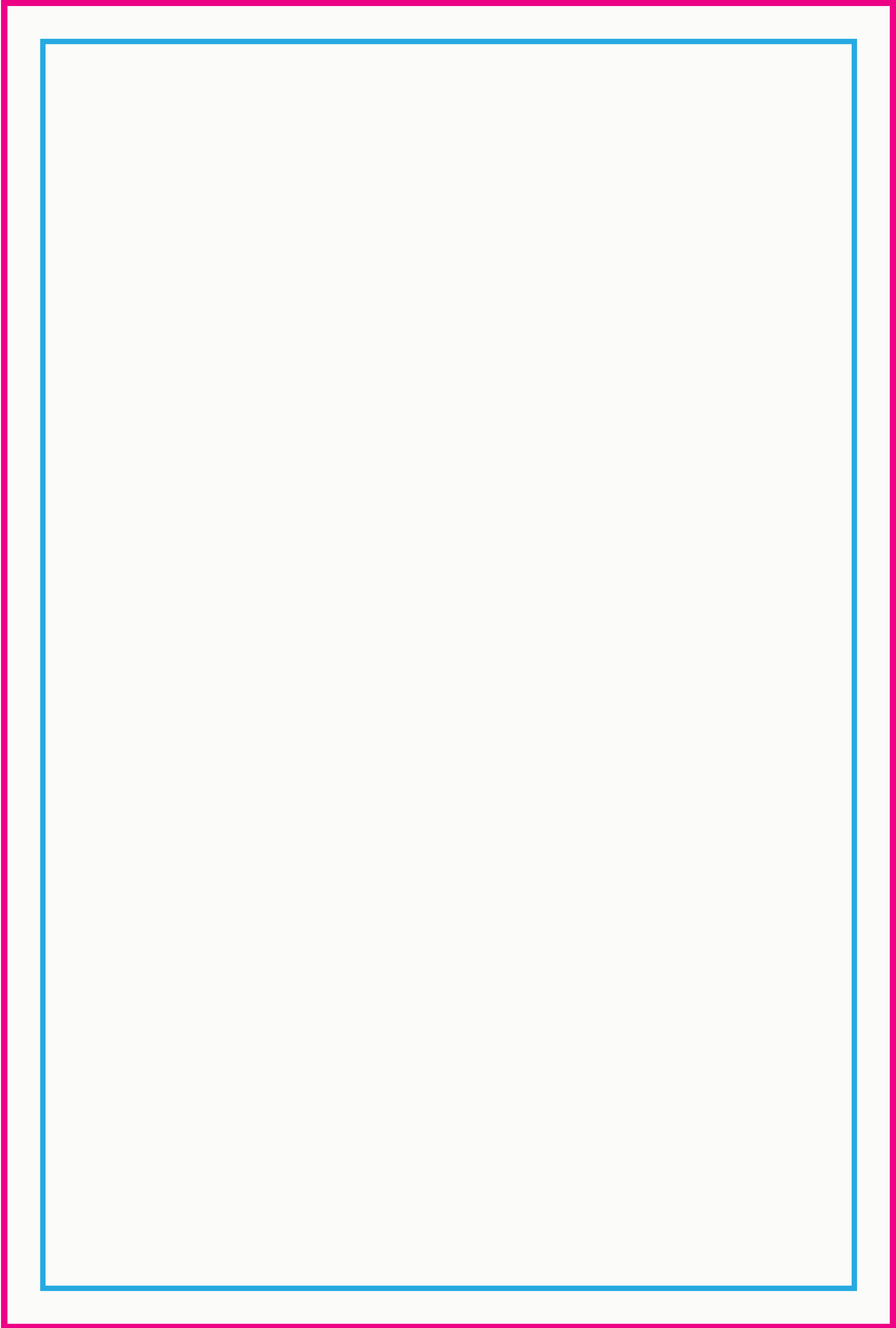
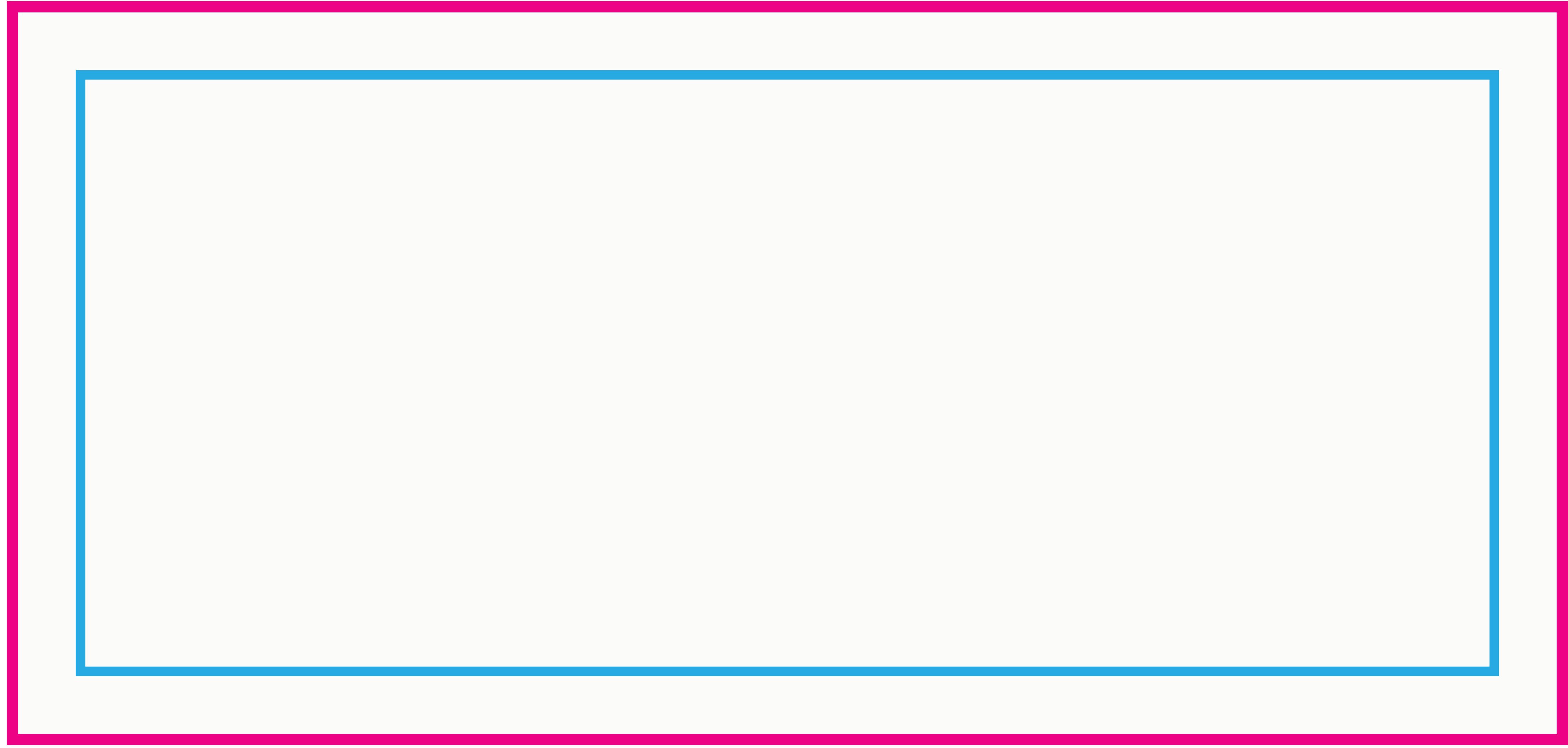

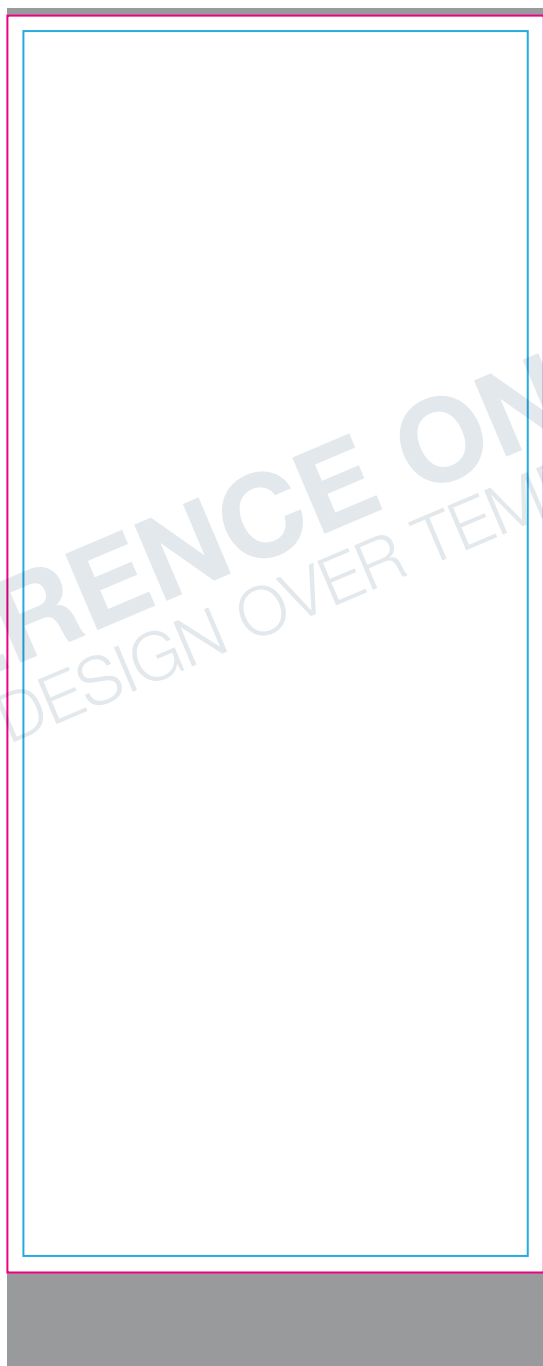



SCALE= 1"=1'-0"

**FOR REFERENCE ONLY
PLEASE USE FULL SIZE
TEMPLATES ON PAGE 2
TO SET UP ARTWORK**

TEMPLATE KEY

-  = BLEED AREA
-  = FINISHED SIZE
-  = SAFE AREA

BLEED AREA

33.5"W x 85"H
(.5" top / 6" bottom)

Area of art that is used for finishing product. Background color/image should extend into this area.

FINISHED SIZE

33.5"W x 78.5"H

Area of art that is visible after finishing product. Background color/image should extend into the bleed area.

SAFE AREA

31.5"W x 76.5"H

Recommended area to place artwork. Artwork within this area will be safe from variance in cut of finished edge /stitch line.

Using PMS colors in your art is recommended but an exact match cannot be guaranteed.

Digital products are printed CMYK (4 color) process from your file.

- All images must be embedded
- All fonts must be outlined.

ACCEPTABLE FILE FORMATS:



Vector lines



Vector image

- Adobe Illustrator (.ai, .pdf, .eps)
- All Fonts Outlined
- Images Embedded



Raster image



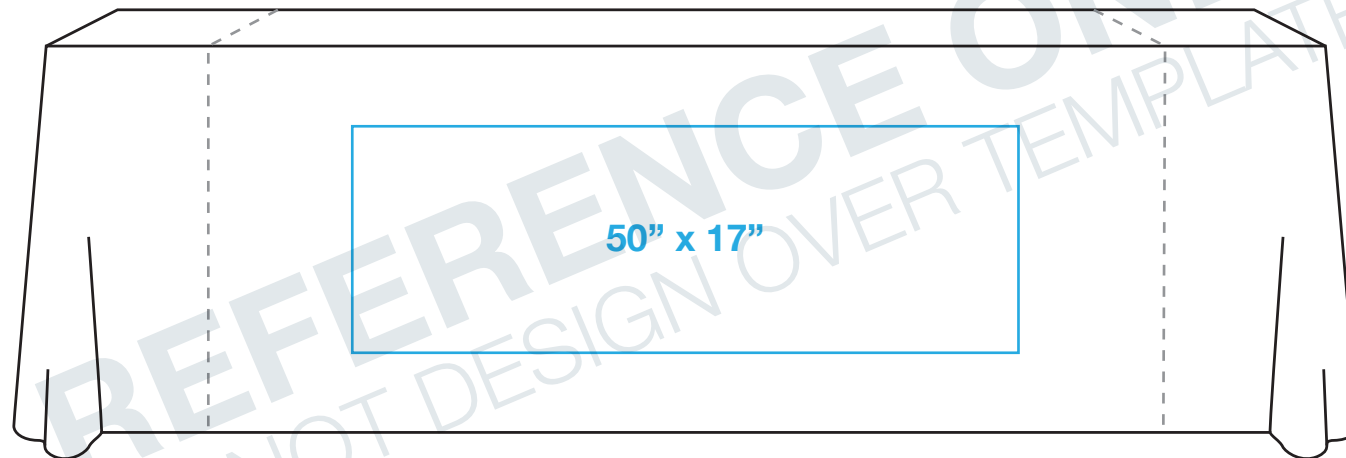

- Adobe Photoshop (.psd, .tif, .jpg)
- 200 DPI at 100% Scale

Updated: 11.28.12





TEMPLATE KEY

	=	BLEED AREA
	=	FINISHED SIZE
	=	SAFE AREA
	=	STITCH LINE

BLEED AREA

N/A

No Bleed Required

Area of art that is used for finishing product. Background color/image should extend into this area.

FINISHED SIZE

See Template for Sizing

Area of art that is visible after finishing product. Background color/image should extend into the bleed area.

STITCH LINE

N/A

SAFE AREA

See Template for Sizing

Recommended area to place artwork. Artwork within this area will be safe from variance in cut of finished edge /stitch line.

- All images must be embedded
- All fonts must be outlined.
- Minimum 1/8" line thickness, all fonts must be outlined, minimum font size 1/4" (30pt) at final imprint size.

Using PMS colors in your art is recommended but an exact match cannot be guaranteed.

Digital products are printed CMYK (4 color) process from your file.

ACCEPTABLE FILE FORMATS:



Vector lines



Vector image

- Adobe Illustrator (.ai, .pdf, .eps)
- All Fonts Outlined
- Images Embedded