

**IMPORTANT NOTE:**

**THIS TEMPLATE SHOWS PRINT LAYOUT ONLY.**

**EACH BANNER HAS ITS OWN UNIQUE ANGLE AND STRETCH WHEN ATTACHED TO THE FRAME.**

**IT IS HIGHLY RECOMMENDED TO KEEP TEXT AND LOGOS WITHIN THE SAFE AREA TO AVOID DISTORTION.**

SEE PAGE 2 FOR REPRESENTATION OF POSITION ON FRAME



**BANNER C: 29.5"W x 28.5"H**  
QTY: 4

**BANNER H (VERTICAL):**  
26.75" W x 90.875" H  
QTY: 1

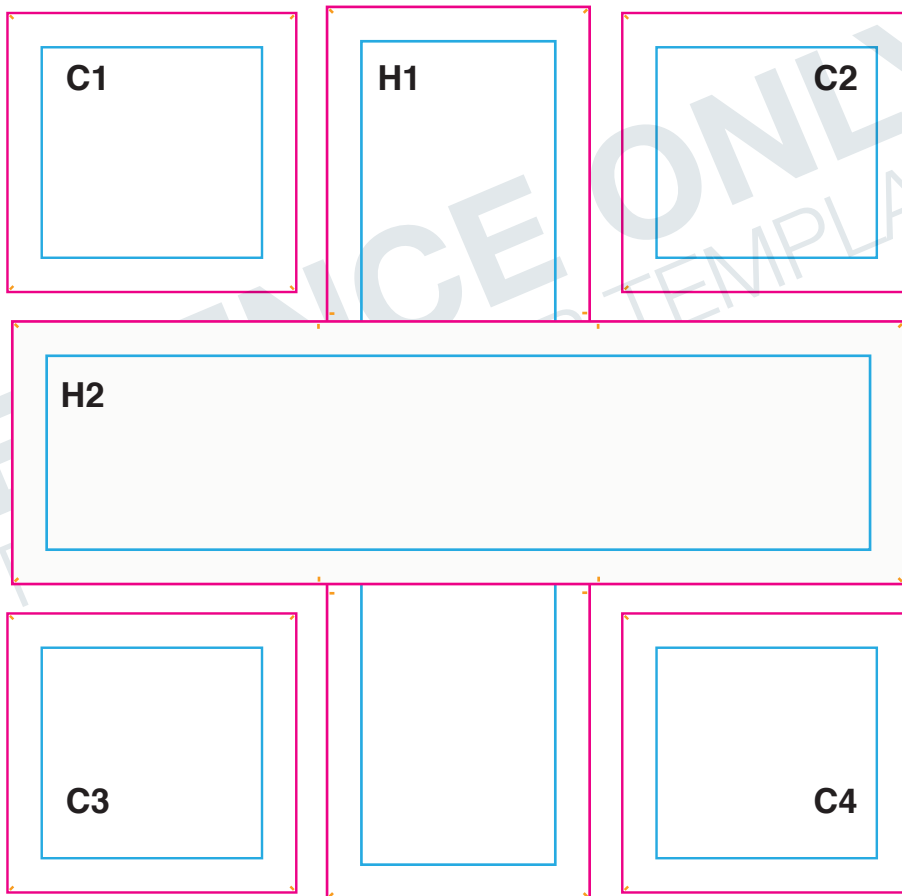
**BANNER H (HORIZONTAL):**  
90.875" W x 26.75" H  
QTY: 1



**TEMPLATE KEY**

-  = FINISHED SIZE
-  = SAFE AREA
-  = PIN SLOT

**FINISHED SIZE**

See Following Pages

Area of art that is visible after finishing product. Background color/image should extend into the bleed area.

**SAFE AREA**

3.5" from finished edge

Recommended area to place artwork. Artwork within this area will be safe from variance in cut of finished edge /stitch line.

**Using PMS colors in your art is recommended but an exact match cannot be guaranteed.**

**Dye-Sub products are printed CMYK (4 color) process from your art file.**

**FOR REFERENCE ONLY**

**PLEASE USE THE FULL SIZE TEMPLATES ON FOLLOWING PAGES TO SET UP ARTWORK**

- All images must be embedded
- All fonts must be outlined.
- Shapes and fonts no smaller than .5" / 60pt.

**ACCEPTABLE FILE FORMATS:**



- Adobe Illustrator (.ai, .pdf, .eps)
- All Fonts Outlined
- Images Embedded



- Adobe Photoshop (.psd, .tif, .jpg)
- 200 DPI at 100% Scale

**EACH BANNER IS FABRICATED  
TO FIT A SPECIFIC  
ANGLE/POSITION ON THE  
FRAME.**

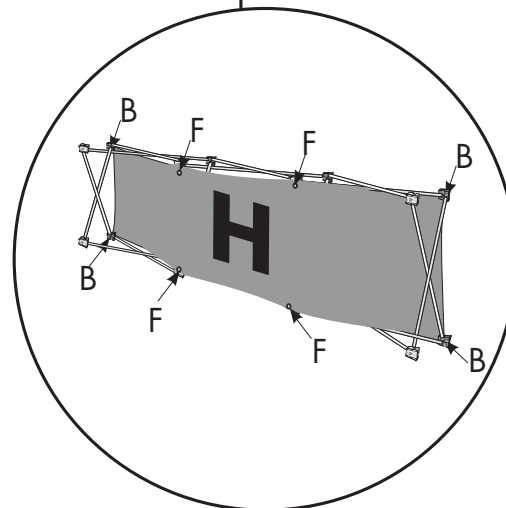
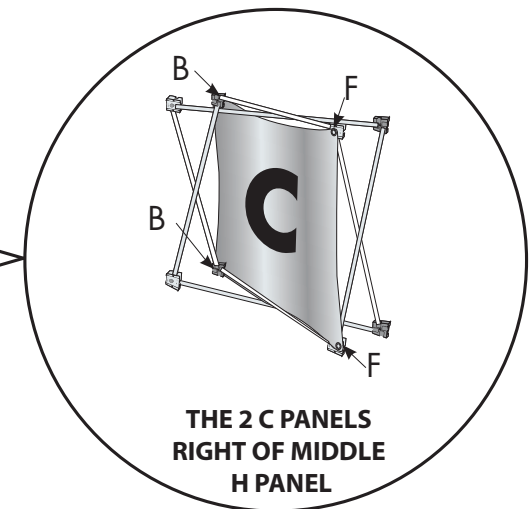
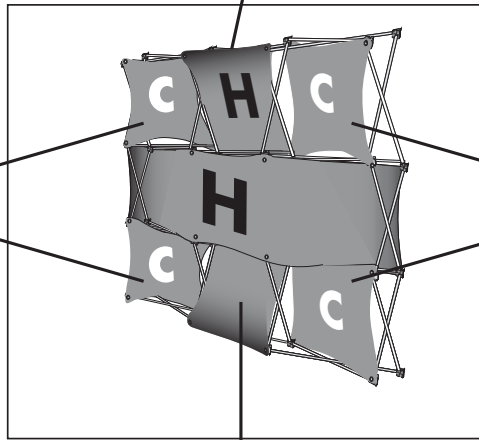
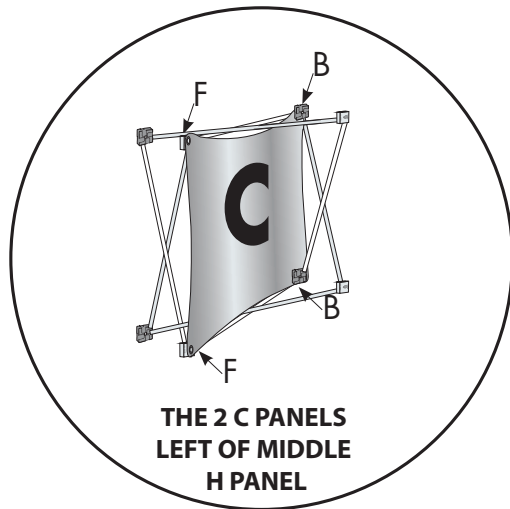
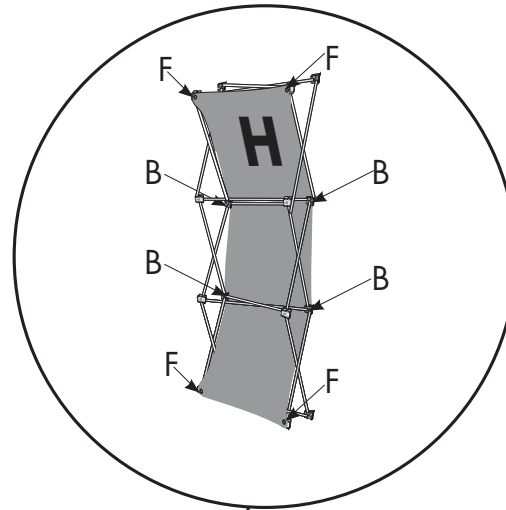

**B=BACK  
F=FRONT**

Item# 337128, 337118, 337107





## BANNER C

-  = FINISHED SIZE
-  = SAFE AREA
-  = PIN SLOT

### FINISHED SIZE 29.5"W x 28.5"H

Area of art that is visible after finishing product. Background color/image should extend into the bleed area.

### STITCH LINE serged edges/pin slots

### SAFE AREA 22.5"W x 21.5"H

Recommended area to place artwork. Artwork within this area will be safe from variance in cut of finished edge /stitch line.



**Using PMS colors in your art is recommended but an exact match cannot be guaranteed.**

**Dye-Sub products are printed CMYK (4 color) process from your art file.**


- All images must be embedded
- All fonts must be outlined.
- Shapes and fonts no smaller than .5" / 60pt.



**BANNER H  
VERTICAL**

-  = FINISHED SIZE
-  = SAFE AREA
-  = PIN SLOT

**FINISHED SIZE**  
26.75"W x 90.875"H  
Area of art that is visible after finishing product. Background color/image should extend into the bleed area.

**STITCH LINE**  
serged edges/pin slots

**SAFE AREA**  
19.75"W x 83.875"H  
Recommended area to place artwork. Artwork within this area will be safe from variance in cut of finished edge/stitch line.

Using PMS colors in your art is recommended but an exact match cannot be guaranteed.

Dye-Sub products are printed CMYK (4 color) process from your art file.

- All images must be embedded
- All fonts must be outlined.
- Shapes and fonts no smaller than .5" / 60pt.



**BANNER H  
HORIZONTAL**

— = FINISHED SIZE  
— = SAFE AREA  
— = PIN SLOT

**FINISHED SIZE**  
90.875"W x 26.75"H  
Area of art that is visible after finishing product. Background color/image should extend into the bleed area.

**STITCH LINE**  
serged edges/pin slots

**SAFE AREA**  
83.875"W x 19.75"H  
Recommended area to place artwork. Artwork within this area will be safe from variance in cut of finished edge /stitch line.

Using PMS colors in your art is recommended but an exact match cannot be guaranteed.

Dye-Sub products are printed CMYK (4 color) process from your art file.

- All images must be embedded
- All fonts must be outlined.
- Shapes and fonts no smaller than .5" / 60pt.